

HART/ Modbus Serial Gateway HTM-611

User Manual

REV 2.2



SiboTech Automation Co., Ltd.

Technical Support: +86-21-5102 8348

E-mail: support@sibotech.net

Catalog

1 Product Overview.....	4
1.1 Product Function.....	4
1.2 Product Features.....	4
1.3 Technical Specifications.....	4
1.4 Safety and Explosion-Proof Features.....	5
1.5 Related Products.....	5
2 Quick Start Guide.....	6
2.1 Configuration of Gateway Parameters.....	6
2.1.1 Pre-configured Settings.....	6
2.1.2 Software Configuration.....	6
2.2 Function Demo.....	9
3 Hardware Descriptions.....	11
3.1 Product Appearance.....	11
3.2 Indicators.....	12
3.3 DIP Switch/Button.....	12
3.3.1 DIP Switch.....	12
3.3.2 Modbus Address Setting Button.....	13
3.3.3 Internal/External Sampling Resistor Switch.....	13
3.4 Interface.....	14
3.4.1 Power Interface.....	14
3.4.2 RS-485/RS-422 Interface.....	14
3.4.3 RS-232 Interface.....	15
3.4.4 HART Interface.....	16
3.4.5 Mini B Type USB.....	16
3.5 Topology of HTM-611 and Fieldbus Devices.....	17
4 Software Instructions.....	19
4.1 Software Interface Description.....	19
4.2 Software Functional Specifications.....	21
4.2.1 Connect with the Hardware.....	21
4.2.2 Upload configuration.....	22
4.2.3 Configure the Fieldbus.....	22
4.2.4 Configure the HART Fieldbus.....	24
4.2.5 Conflict Detection.....	31
4.2.6 AutoMap.....	32
4.2.7 Download Configuration.....	33
4.2.8 Memory Data Display.....	33
4.2.9 Diagnose.....	34
4.2.10 Serial Debug.....	38



HTM-611
HART/Modbus Serial Gateway
User Manual

4.2.11 Switching Tools.....	39
5 Working Principle.....	40
5.1 Flowchart of Executing One HART Command.....	43
5.2 Universal Send and Receive Data.....	43
5.3 Trigger Command.....	44
5.4 Data Exchange with Modbus.....	45
6 Installation.....	46
6.1 Machine Dimension.....	46
6.2 Installation Method.....	46

1 Product Overview

1.1 Product Function

HTM-611 is a gateway that can provide a seamless connection between HART and Modbus. At HART side it can be configured as a primary master or the secondary master, and acts as slave at the Modbus side.

1.2 Product Features

- Powerful Serial function: Support the interconnection between HART and Modbus , also support transparent transmission between HART and serial port.
- Multi debugging functions: It can display the exchanging data, and diagnosis the HART command

1.3 Technical Specifications

- [1] Used as a primary or a secondary HART master;
- [2] Supports one HART-channel, under multi-point mode, support connecting at most 13 HART slaves with gateway internal resistor and support connecting 15 HART slaves with an external resistor (250Ω);
- [3] Supports single-point and multi-point mode at the HART side;
- [4] Under single-point mode, support data burst operation;
- [5] Supports all commands of the HART protocol;
- [6] Each HART command can be configured for change-of-state output, polling output, initialization output or disable output;
- [7] Supports up to 128 HART commands, HART output data buffer is up to 1000 bytes, and the input data buffer is up to 1600 bytes;
- [8] Supports an internal or external HART sampling resistor;
- [9] Supports serial RS-232, RS-485 and RS-422, baud rate supports: 300, 600, 1200, 2400, 4800, 9600, 19.2K,

38.4K, 57.6K, 115.2Kbps;

[10] The serial port can be configured as Modbus slave, supports modbus function code: 03H, 04H, 06H, 10H;

[11] Modbus slave supports RTU and ASCII communication;

[12] The serial port can be configured as universal mode, and achieve transparent data transmission with HART slave devices;

[13] Power: 24VDC (9V~30V), 80mA (24VDC);

[14] Working circumstance temperature: -4°F~140°F (-20°C~60°C), Humidity: 5%~95%;

[15] External dimensions (W*H*D): 0.98 in*3.94 in *3.54 in (25mm*100mm*90mm);

[16] Installation: 1.38 in (35mm) DIN RAIL;

[17] Protection Level: IP20;

1.4 Safety and Explosion-Proof Features

HTM-611 is not the product with the features of safety and explosion-proof, please put it in the control room when using.

1.5 Related Products

The related products include: GT200-HT-DP, GT200-DP-RS etc.

If you want to get more information about these products, please visit SSTCOMM website:

<http://www.sstcomm.com>.

2 Quick Start Guide

The following example introduces the use method of the Gateway.

2.1 Configuration of Gateway Parameters

2.1.1 Pre-configured Settings

1. Turn gateway's configuration bit of DIP switch(refer to chapter 3.3.1) to "ON";
2. Connect the Gateway's RS-232 interface and the serial port of the computer with a serial cable, wiring methods see chapter 3.4.3 of this manual;
3. Power on the gateway, the LED display show "CF", indicates that the gateway is in the configuration mode.
Run the HT-123 to start the gateway configuration.

2.1.2 Software Configuration

1. Run the HT-123 software installed on your computer.
2. Click "Fieldbus" in the tree view on the left, the configuration table is shown on the right as below:

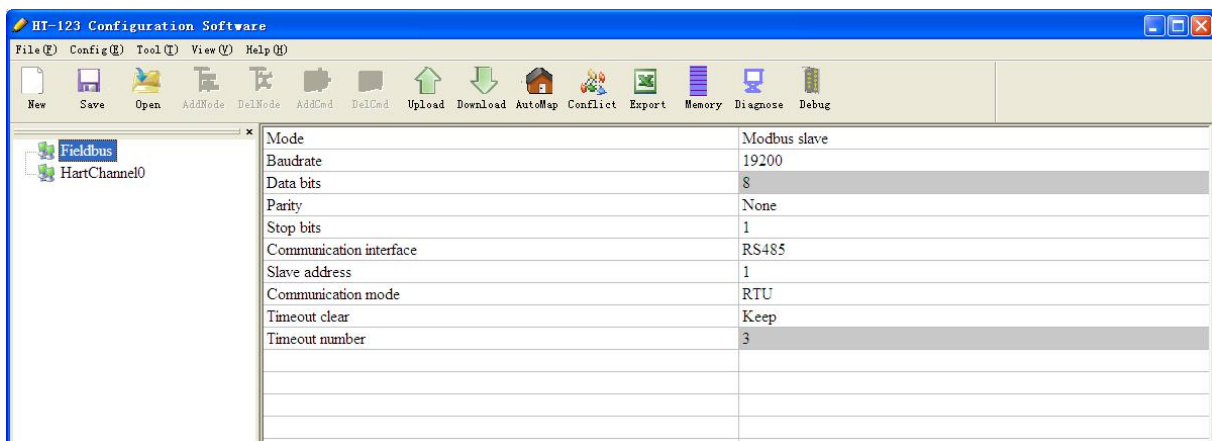

HTM-611 HART/Modbus Serial Gateway User Manual

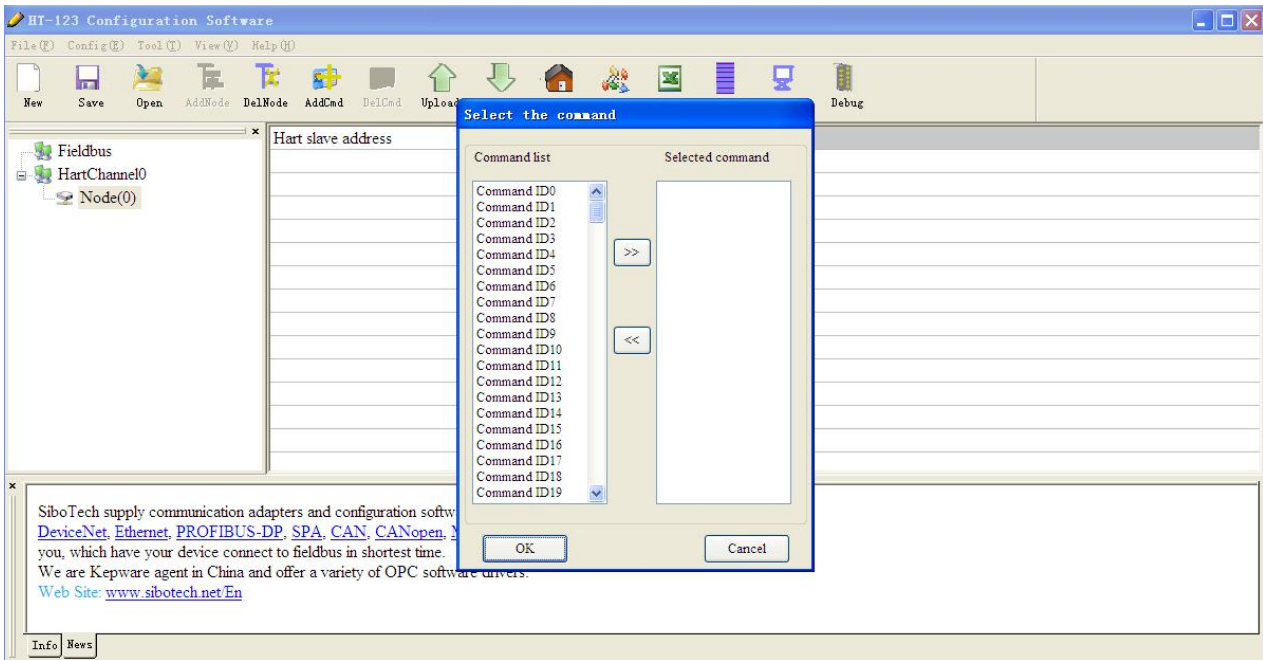

6. Click the “Command ID1”, the configuration table on the right is configured as below:

Configuration Mode	Basic
Mode of outputting commands	Polling output
Memory starting address of sending data	3000
Modbus register starting address of sending data	0
Sending data length (BYTE)	0
Sending data length (WORD)	0
Memory starting address of receiving data	0
Modbus register starting address of receiving data	0
Receiving data length (BYTE)	7
Receiving data length (WORD)	4
Command index	0



Download

7. Click the tool  , in the pop-up dialog box, select the serial port that gateway is connected to the computer, click OK and then click Download data:



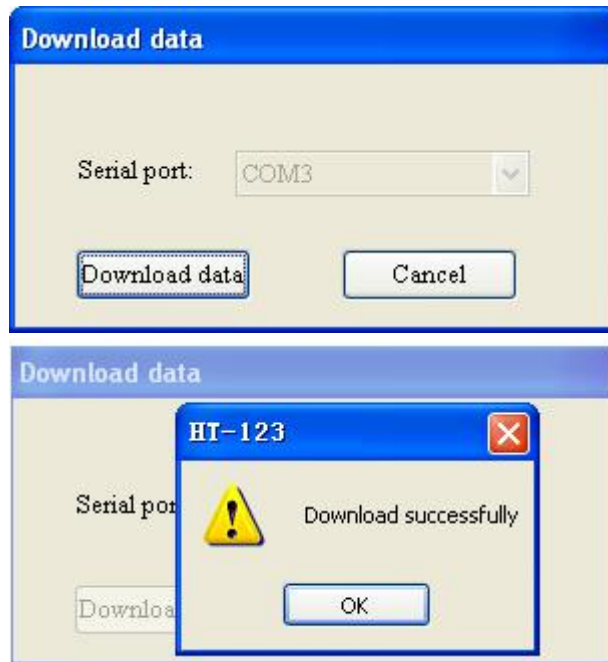

2.2 Function Demo

HART interface of the gateway connects with a 2-wire pressure transmitter with slave address 0, RS-485 interface is connected to the computer through RS-485/RS-232 converter, and computer with configured Modbus POLL software can simulate to work as a Modbus master, then in data exchange window you can see the main variable value of the pressure transmitter:

HTM-611 HART/Modbus Serial Gateway User Manual

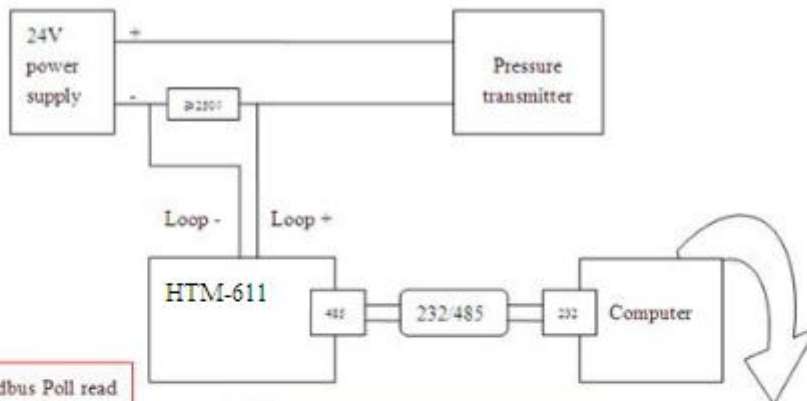

The Modbus Poll read the HART data "00,00,0B,42,8F,FE,32", where the front double "00" means that the device is in normal state, "0B" indicates that the pressure unit is PSI, "42, 8F, FE, 32" means the pressure value, the value is 71.9964752197266 (psi) .

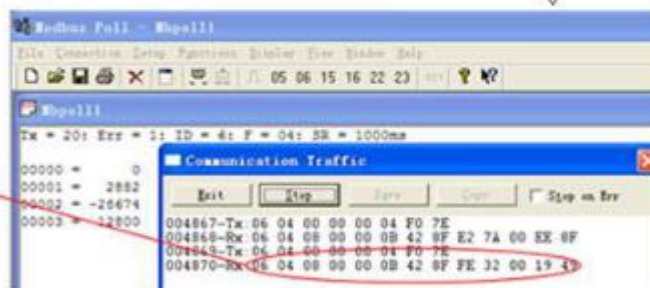

3 Hardware Descriptions

3.1 Product Appearance

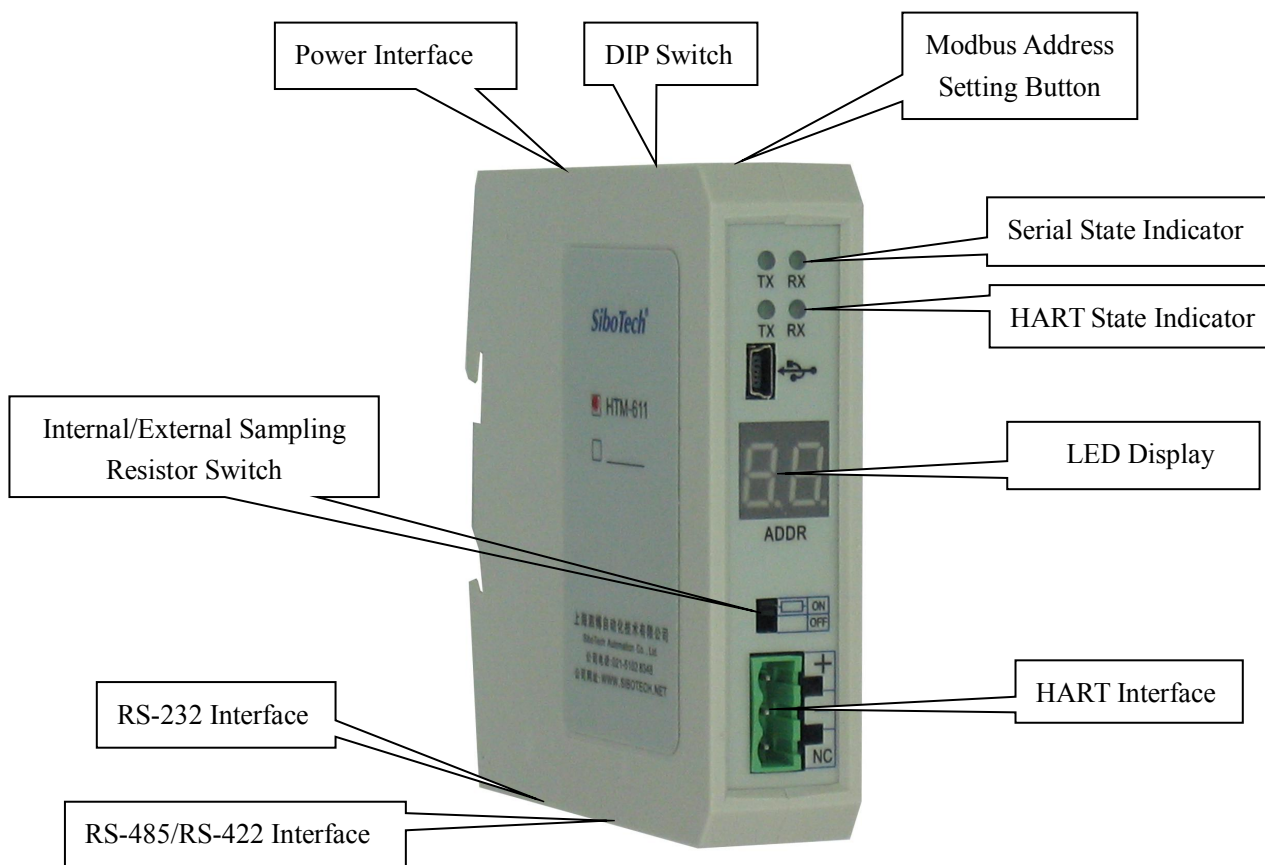

Note: This picture is for reference only. Product appearance should refer to the real object.

3.2 Indicators

Indicator location	Indicator	State	State Description
Row 1	TX	Blinking	Serial port data sending
		OFF	No data is sending
	RX	Blinking	Serial port data receiving
		OFF	No data is receiving
Row 2	TX	Blinking	HART Bus data sending
		OFF	No data is sending
	RX	Blinking	HART Bus data receiving
		OFF	No data is receiving

3.3 DIP Switch/Button

3.3.1 DIP Switch

The DIP switch is located at the bottom of product, bit 1 is the debug bit and bit 2 is the configuration bit.

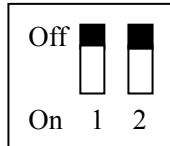

Debugging (bit 1)	Configuration (bit 2)	Description
Off	Off	Run Mode
Off	On	Configuration Mode
On	Off	Debug Mode
On	On	Configuration Mode

Note: ①After re-configuring the switch, you have to restart the HTM-611 to make the settings take effect!
(Power off then Power On)

②Set to the debug mode, it will be compulsory to appoint RS-485 interface as communication interface, RS-232 interface as debugging interface.

③Configuration interface uses the RS-232 interface.

3.3.2 Modbus Address Setting Button

Under run mode of the HTM-611, LED display always displays the address of the current Modbus address. Quickly press (double-click) the button twice in succession, the high bit starts to flash, and the low bit is always on, click the button to add 1 to start setting the high bit of Modbus address. Long-press the button for 3 seconds, the high bit is always on, and the low bit starts to flash. Click the button to add 1 to start setting the low bit of Modbus address. At last, long-press the button again for 3 seconds, the address flashing three times shows that the address is set successfully. If no button action within ten seconds, HTM-611 exits the status of setting address and continue to display the original address. The configurable range of Modbus address is 0 to 99 (Decimal).

3.3.3 Internal/External Sampling Resistor Switch

HTM-611 can choose using the internal sampling resistor or external sampling resistor to get the HART signal. The specification of the internal resistor is 270Ω, 2W. When the power of the sampling resistor is more than 2W, you must use an external resistor.

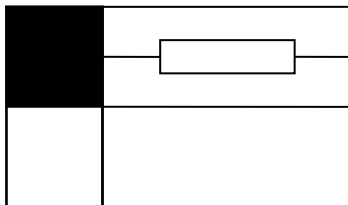

Switch to ON, using the internal sampling resistor

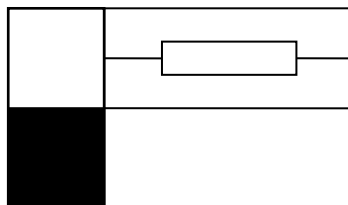

Switch to OFF, using the external sampling resistor

3.4 Interface

3.4.1 Power Interface

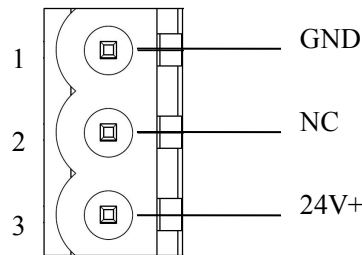

Pin	Function
1	Power GND
2	NC(Not Connected)
3	24V+, DC Positive 24V

3.4.2 RS-485/RS-422 Interface

The RS-485 interface of HTM-611 is a standard one, and the RS-485 characteristics of the product are shown as follows:

1. The basic characteristics of RS-485 transmission technology

- ① Network topology: Linear bus, there are active bus terminal resistors at both sides.
- ② Transmission rate: 1200 bps~115.2Kbps.
- ③ Media: Shielded twisted-pair cable and also can cancel the shielding, depending on environmental conditions (EMC).
- ④ Site number: 32 stations per subsection (without repeater), and can increase up to 127 stations (with repeater).
- ⑤ Plug connection: 3/5-pin pluggable terminal.

2. The main points on the installation of RS-485 transmission equipment

- ① All the equipment are connected with RS-485 bus;

②Each subsection can be connected up to 32 sites;

③The farthest two end of the bus has a terminal resistor—120Ω 1/2W to ensure reliable operation of the network.

Serial interface uses 5-pin pluggable open terminal and user can wire it according to the wiring instructions on the panel.

5-pin terminal:

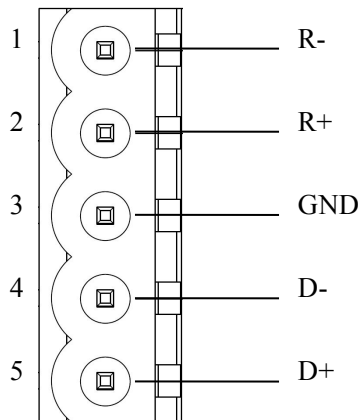

Pin	Function
1	R-, RS-422 Receive Negative
2	R+, RS-422 Receive Positive
3	GND
4	D-, RS-485/RS-422 Transmit Negative
5	D+, RS-485/RS-422 Transmit Positive

3.4.3 RS-232 Interface

RS-232 interface uses one 3-pin pluggable open terminal, and its pin description is shown as follows:

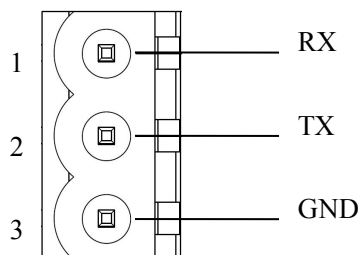

Pin	Function
1	RX, Connect RS-232's RX of user device
2	TX, Connect RS-232's TX of user device
3	GND, Connect RS-232's GND of user device

3.4.4 HART Interface

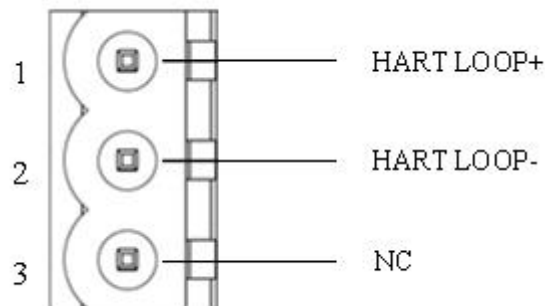

Pin	Function
1	Connect HART signal positive
2	Connect HART signal negative
3	NC

3.4.5 Mini B Type USB

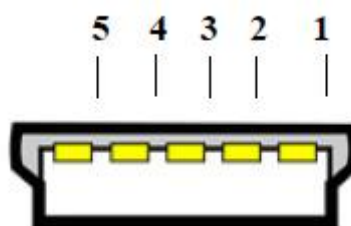

Mini B type USB interface is defined as below:

HTM-611 HART/Modbus Serial Gateway

User Manual

Pin	Name	Function
1	VBUS	+5V
2	D-	Data negative
3	D+	Data positive
4	IN	NC
5	GND	Signal Ground

3.5 Topology of HTM-611 and Fieldbus Devices

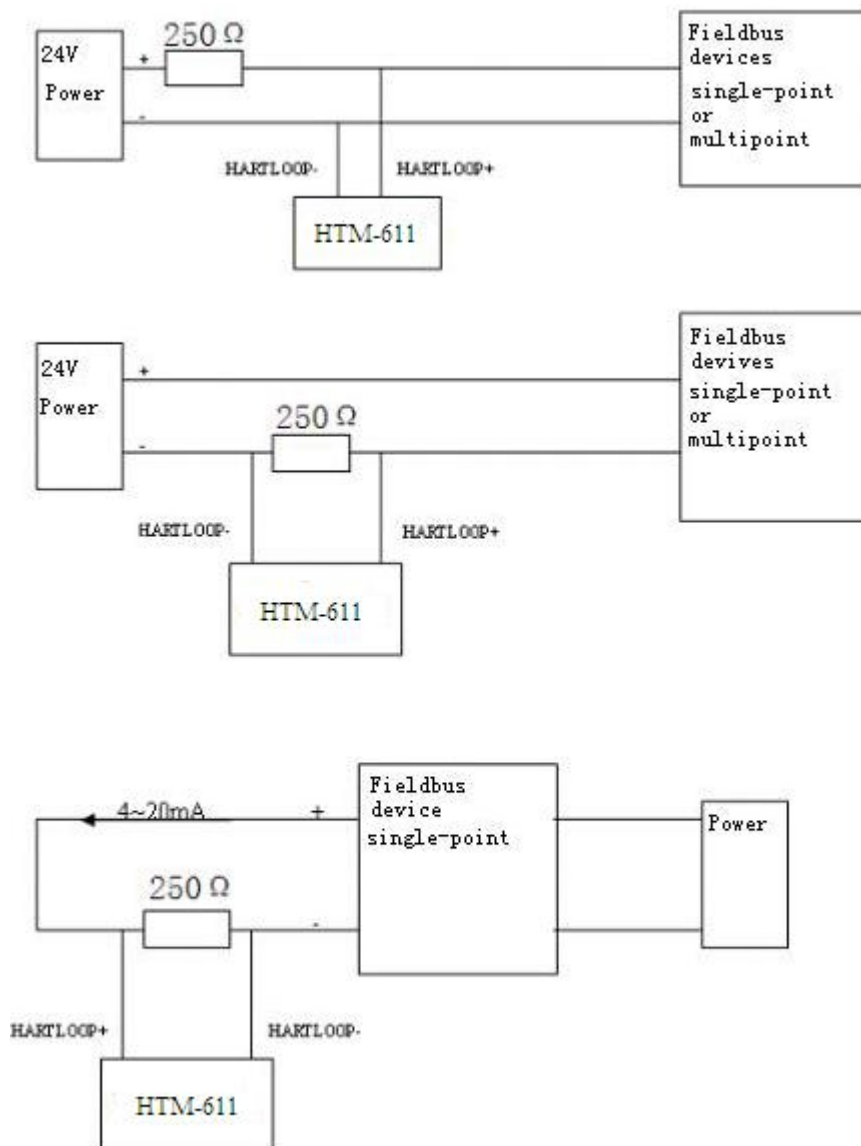

Not using the internal resistor!

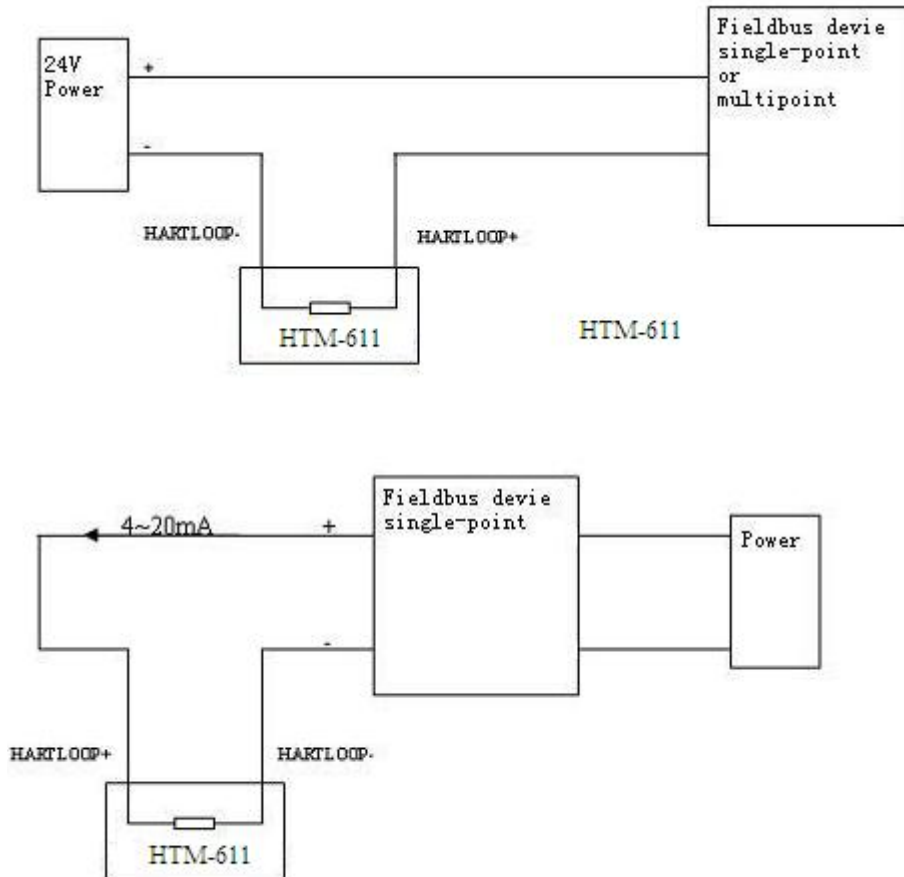

Using the internal resistor!

Note: 1. Some HART slave instrument need to perform self-test and other internal work when power is on, they may not start HART communication, then gateway cannot receive the response data of the instrument right now. It is recommended the HART slave instrument and gateway uses separate power supply so that the gateway can immediately establish communication with instrument.

2. When configuring HART commands in the software HT-123, the commands need to be configured according to the actual demands. To improve the speed of bus communication, it is recommended not to configure the empty node (in fact, not connected to the node) and empty commands (the actual unnecessary commands).

4 Software Instructions

4.1 Software Interface Description

HT-123 is configuring software based on Windows platform, and used to configure HART series products.

The following describes how to use the software HT-123 to configure the product HTM-611. You may also check the software user manual to get detailed usage.



Double-click on the icon  to enter the main interface of software:

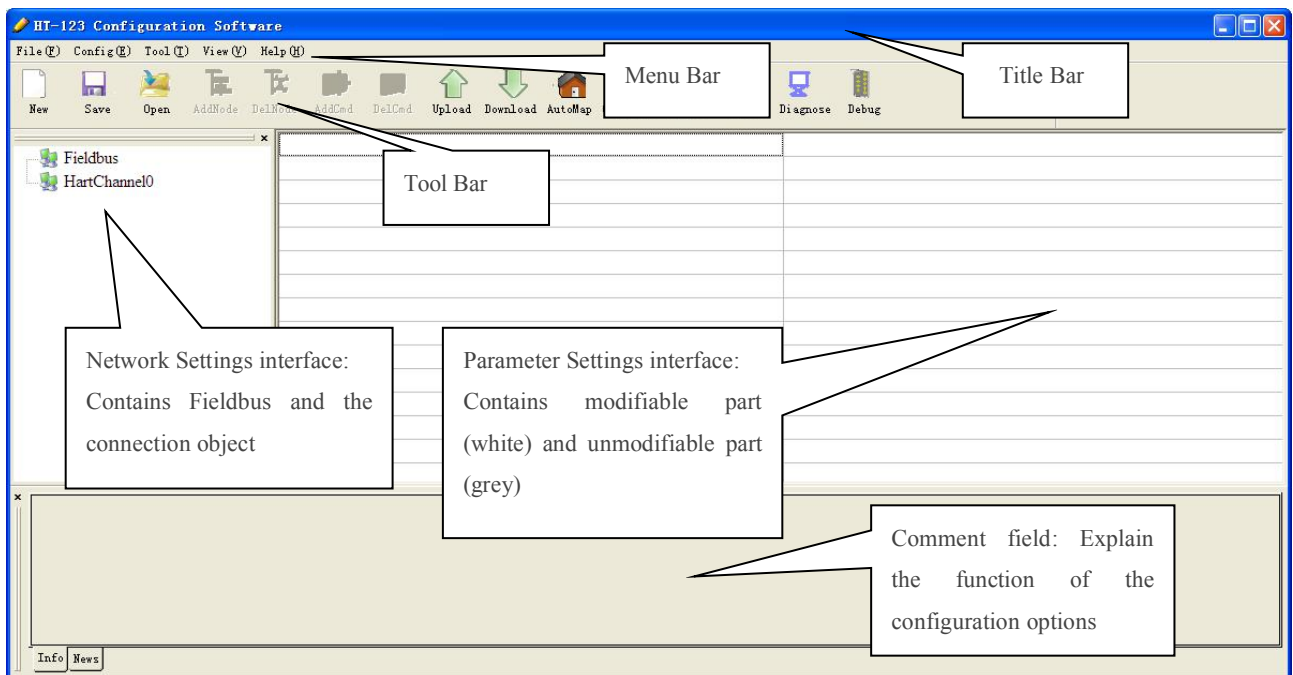

Tool Bar:

Toolbar interface shown as follow:



The function from left to right is: New, Save, Open, AddNode, DelNode, AddCmd, DelCmd, Upload,

HTM-611 HART/Modbus Serial Gateway User Manual

Download, AutoMap, Conflict, Export, Memory, Diagnose and Debug.



New: Create a new configuration file



Save: Save the configuration file



Open: Open the configuration file



AddNode: Add a HART slave node



DelNode: Delete a HART slave node



AddCmd: Add a HART command



DelCmd: Delete a HART command



Upload: Read the configuration information from the module and shown in the software



Download: Download the configuration file to the gateway



AutoMap

AutoMap: Used to automatically calculate the mapped memory address without confliction by each command



Conflict

Conflict: To check whether there are some conflicts with configured commands in the gateway memory data buffer



Export

Export: Output current configuration to the local hard disk and saved as Excel spreadsheet form



Memory

Memory: Show the data exchange inside of the gateway



Diagnose

Diagnose: through this function could analyze operating condition of fieldbus device; also it can finish some certain analysis



Debug

Debug: through this function could send any request frame to Hart fieldbus and show the response information received in HART, convenient to debug

4.2 Software Functional Specifications

4.2.1 Connect with the Hardware

Put the gateway configuration switch to “ON”, use a serial port line to connect the gateway RS-232 port and that of computer. Power on the gateway and its LED display displaying “CF” indicates it is in the configuration mode.

4.2.2 Upload configuration



Open the software “HT-123”, Click on the icon , Select the computer port connected to the gateway and then click “upload data”, If it shows “upload successfully”, which indicates that configuration file had been uploaded to the HT-123.

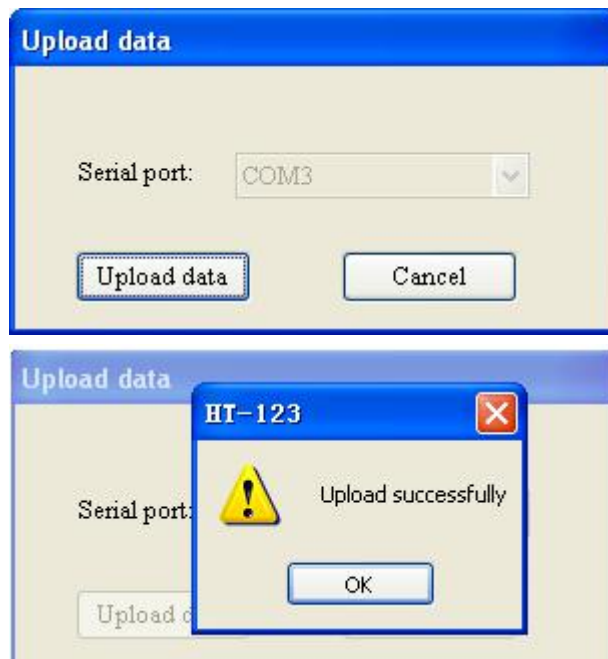

4.2.3 Configure the Fieldbus

4.2.3.1 Configure the fieldbus as Modbus slave

If you want to use the functionality of Modbus slave, click the “Fieldbus” in the tree view, select mode as “Modbus slave” in the right configuration plate, and then press ENTER to confirm, you will see the interface as below:

HTM-611 HART/Modbus Serial Gateway User Manual

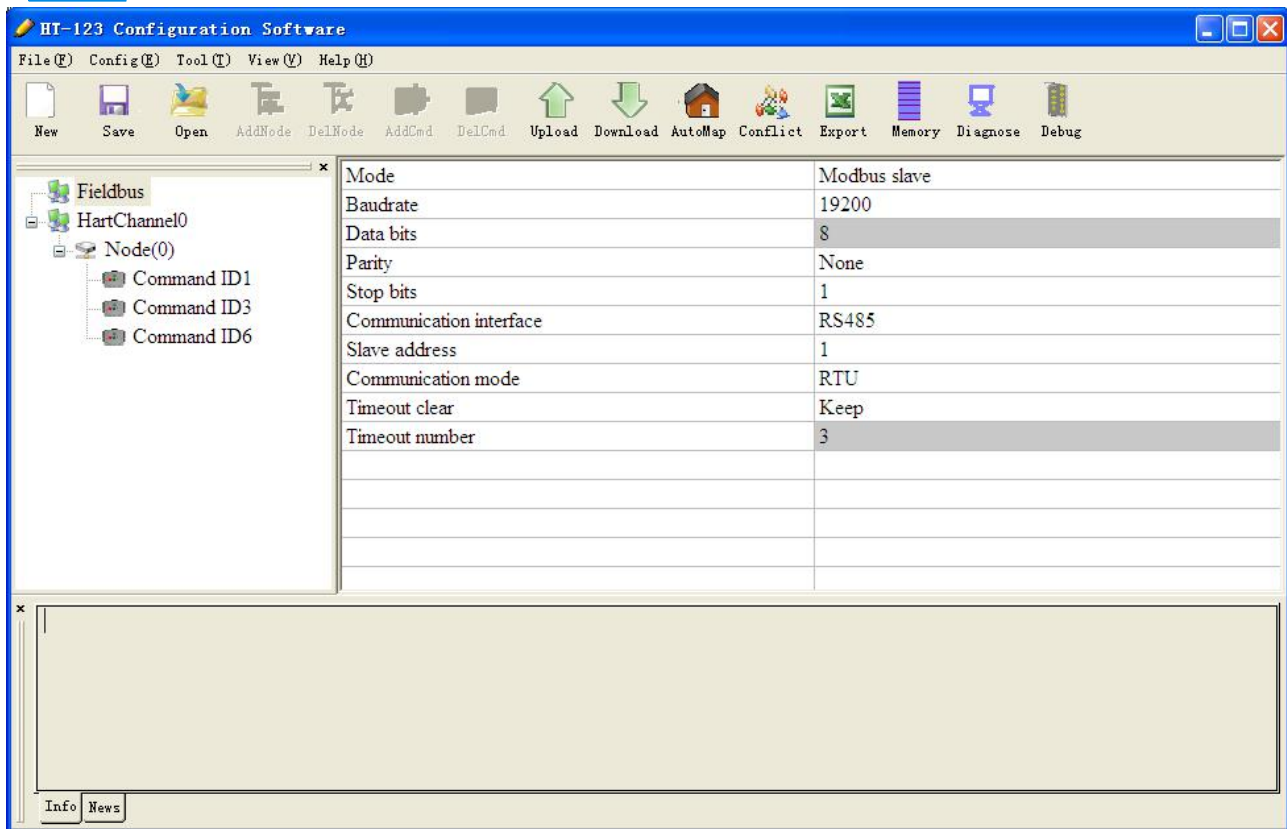

In this interface you can set the parameters as shown:

Baud rate: 300, 600, 1200, 2400, 4800, 9600, 19200, 38400, 57600, 115200bps

Data bits: 8

Parity: None, Odd, Even, Mark, Space optional

Stop bits: 1, 2

Communication mode: RTU, ASCII

Slave address: 0~247

Communication interface: RS-485, RS-232 optional. When the serial need to communicate with RS-422, please choose “RS-485”

Timeout clear: When the HART commands exceed the no-reply times, whether or not to clear the HART input data buffer

Timeout number: set the timeout/clear times

4.2.3.2 Configure the fieldbus as universal mode

The universal mode (transparent transmission mode) means that we can send HART frame directly through serial port (RS-232/RS-485/RS-422), meantime gateway also will send out the data received from HART bus through serial port. In this process, the data don't change.

Click the "Fieldbus" in the tree view, select mode "Universal mode" in the right configuration plate, and then press ENTER to confirm, you will see the interface as below:

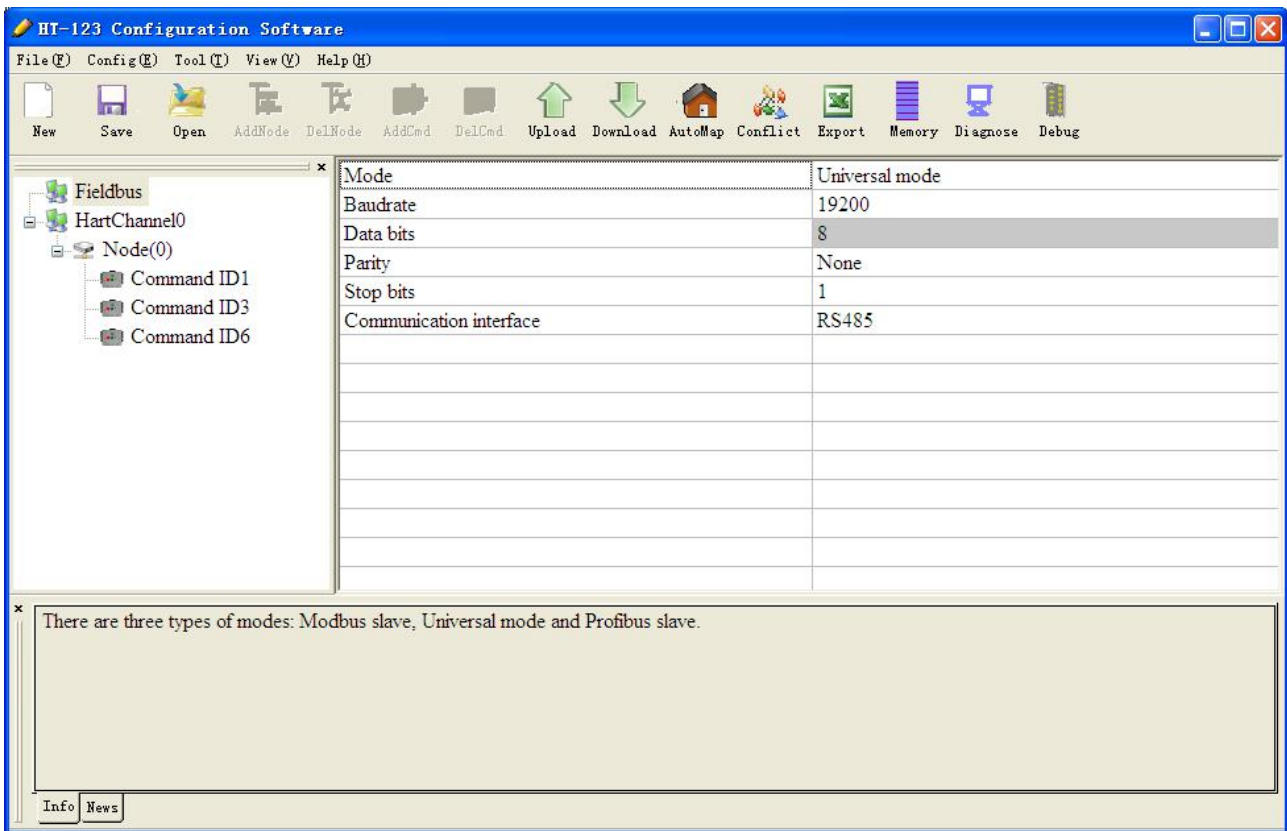

The range and meaning of general mode are the same as "Modbus Slave".

4.2.4 Configure the HART Fieldbus

4.2.4.1 Set the Parameters of HART Channel

Click the HartChannel0 in the tree view, in the right place will show the configuration plate:

HTM-611 HART/Modbus Serial Gateway User Manual

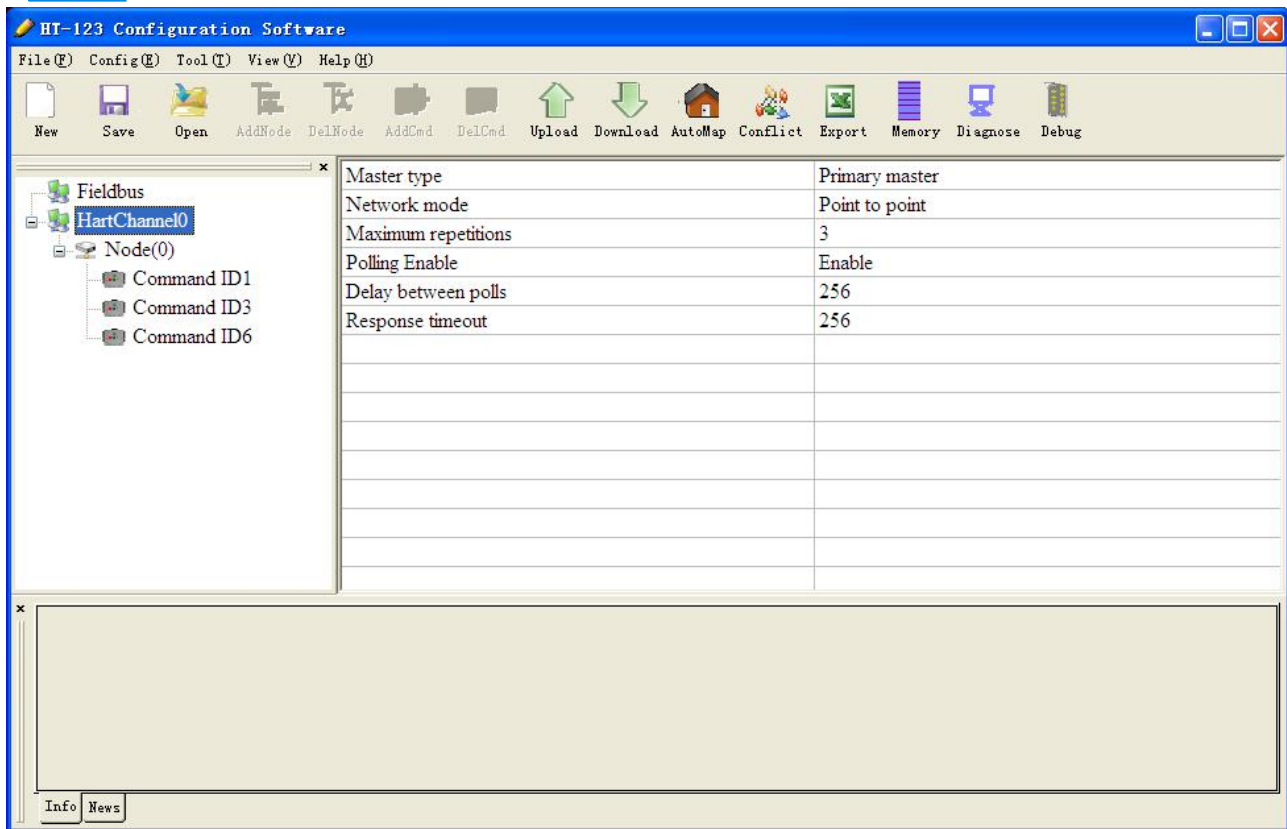

Master type: Primary master, Secondary master

Network mode: Select the networks link as single or multiple points, in the single point the gateway can only communicate with the slave device whose address is 0;

Maximum repetitions: 0~5

Polling Enable: Enable, Disable

Delay between polls: 256~65535ms

Response timeout: 256~65535ms

4.2.4.2 Add Slave Nodes

Select the "HartChannel0", Right click the mouse and click "AddNode".

4.2.4.3 Add HART Commands

Select the “Node (x)”, Right click the mouse and click “Add Command”.



Choose the command you want in the popup menu, and then click “OK” to exit:

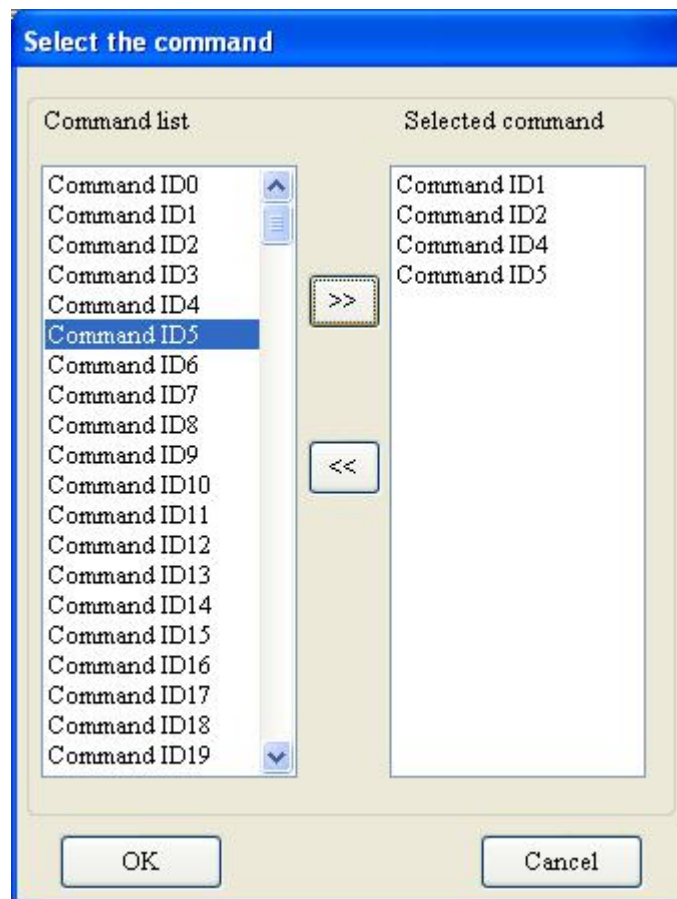

Note: the same command can only be configured once in one node.

4.2.4.4 Configure HART Commands

Click the command number in the tree view; you will see the configuration plate in the right place:

output data length, 1 word=2 byte;

Memory starting address of receiving data: set the memory address of input data by this command. Response data only includes data area of HART frame;

Modbus register starting address of receiving data: the property is automatically calculated by gateway, used for register addressing;

Receiving data length (BYTE): set the length of input data by this command;

Receiving data length (WORD): the property is automatically calculated by gateway, used for user checking output data length conveniently, 1 word=2 byte;

Command index: the property is automatically calculated by the configuration software, it indicates the index in the configured command list this command belongs to.

4.2.4.5 Delete Commands

Select the command need to be deleted, Right click the mouse and click “Delete Command”. Through the menu command can also be the same action.

4.2.4.6 Delete Nodes

Select the node needed to be deleted, Right click the mouse and click “Delete Node”. Through the menu command can also be the same action.

4.2.4.7 Advanced Options to Configure Slave Commands

When using HART command configuration, sometimes users want to get one part data of one command. For example, No.1 HART command. The float value of main variable is only needed, no need to get unit of main variable, this is why advanced option exists. Advanced options is actually the execution of “segment mapping function”, it cut the response data of HART command and get the segment data. Users can get any part data they want. Below is the interface of Advanced Options:

HTM-611 HART/Modbus Serial Gateway User Manual

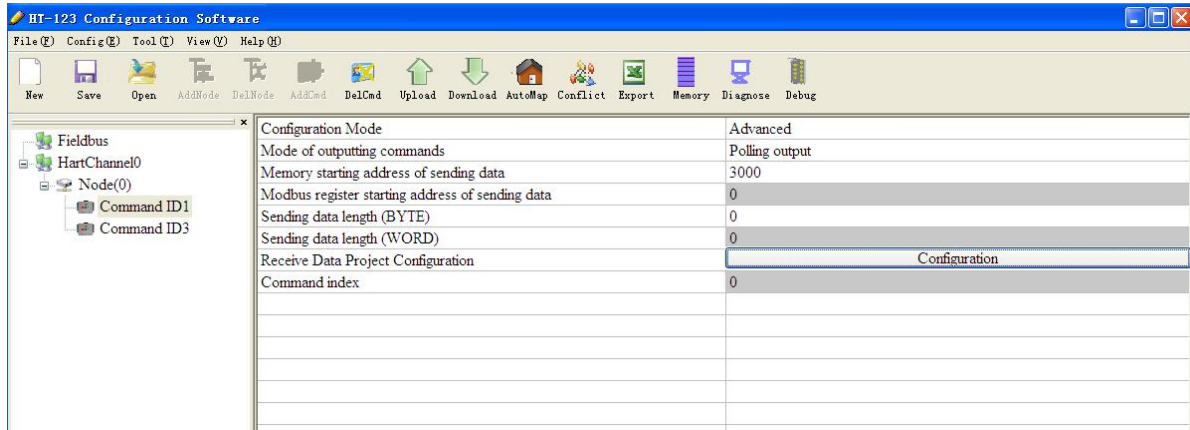

This interface details is described in chapter 4.2.4.4, so here we don't describe it. The below is the example of No.3 HART command, to show how to use "Segment Mapping" function, we can see one "configuration" button after the "receive data project configuration" option, click it:

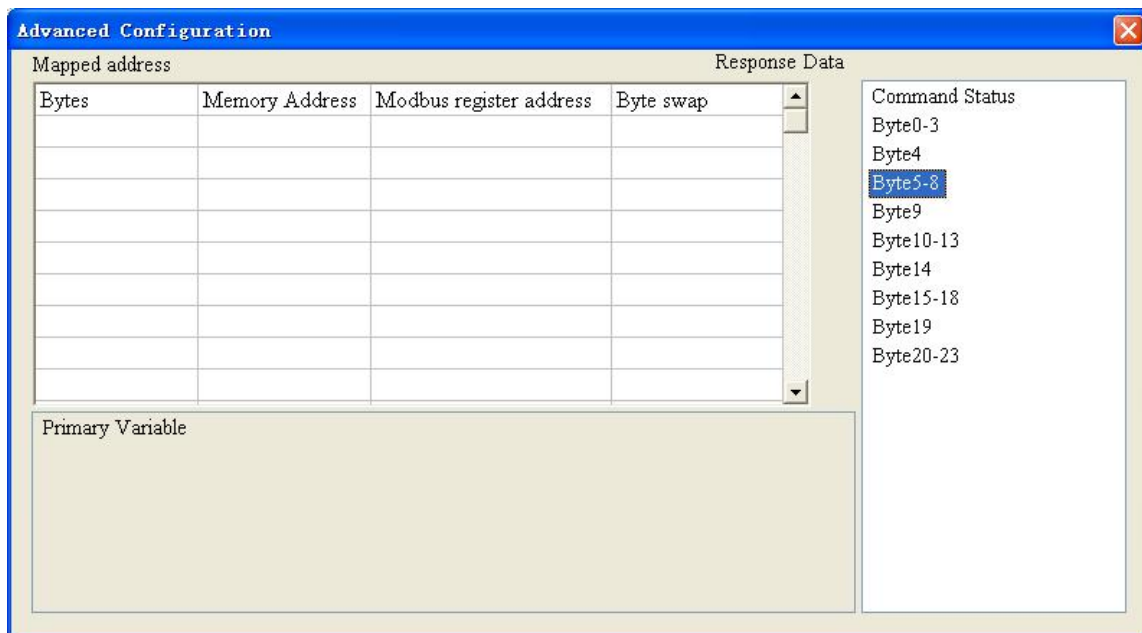

There are many parts in "Bytes". For example, "Command Status" means the communication status and relevant code of HART response command, "Byte0-3" means byte 0 to 3 of data area of HART response command, and so on.

In the above example, click "Byte5-8" will show the Primary Variable in the left bottom area. Other column have the relevant explanation.

First to explain the "Mapped Address":

Bytes: response bytes of “Response Data”;

Memory Address: assigned memory address which this byte is located in memory buffer area of GT200-HT-EI;

Modbus register address: the relevant Modbus register address of “Memory Address”; Note: this address is not a single address, that is the same memory area which it occupied.

Byte swap: there are two options, “no swap” and “register swap”, swap option is only valid to float type data. When using “no swap”, the byte order is byte1, byte2, byte3 and byte4. After using “register swap”, the byte order will be byte3, byte4, byte1 and byte2. For example, the original data is 0x12345678, it will be 0x56781234 after using “register swap”.

Choose “Byte0-3” and “Byte5-8”, click auto mapping, as shown below:

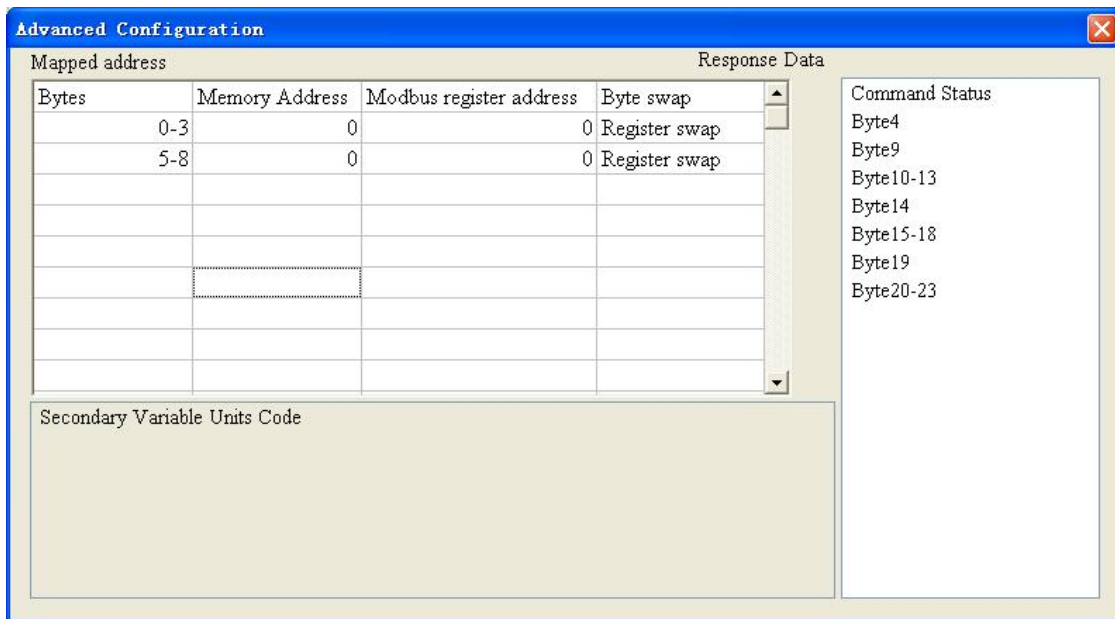

Close the dialog box, download the configuration into HTM-611.

Others are the same with “Basic Mode”.

4.2.5 Conflict Detection

Conflict detection is used to check the distribution condition of the input and output data of all commands

stored in the memory.



Click  icon will show the conflict detection interface as follow:

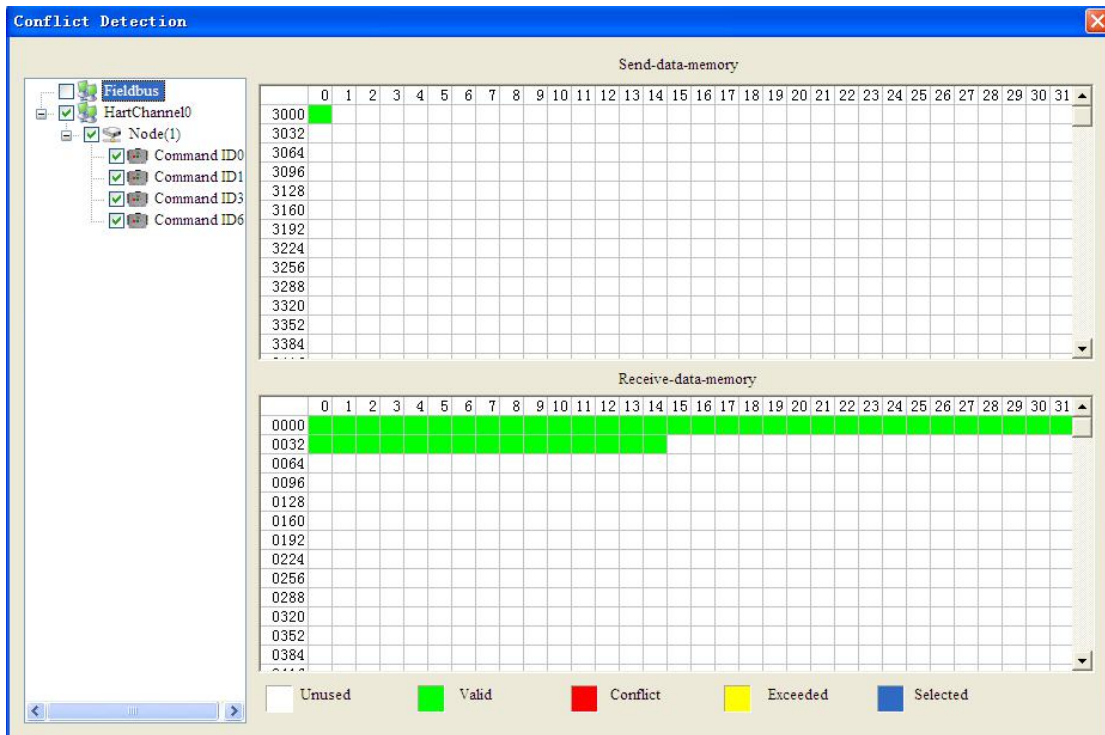

The left side is configuration commands, the right side is data memory address including receive data storage address and send data storage. Upper side is memory distribution of the HART’s sending data; lower side is memory distribution of the HART’s receiving data. When one memory unit is configured with two commands or more, the memory unit will display red color. When the distributed memory exceeds the defined scale of gateway, the exceeding part will display yellow color. White color area shows the usable memory. Green color area indicates occupied memory. Clicking one command, the distribution chart shown in blue will show the storage location of input/output data.

4.2.6 AutoMap

Automap will automatically distribute the memory with no conflict according to the input/output bytes number by users’ commands.



You should set the correct input/output bytes for each commands, then click  label, select “yes” in the popup menu.

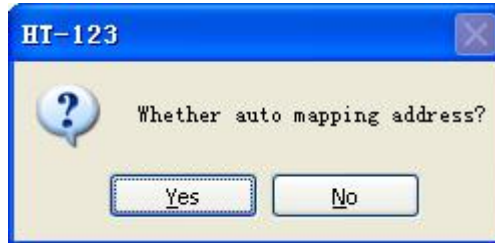

4.2.7 Download Configuration



Click the icon ; it will download the configuration into the gateway.

4.2.8 Memory Data Display

Show the data exchange inside of the gateway, users can use this function to debug the HART fieldbus in the absence of the Modbus master station. Steps are as follows:

1. Set the DIP switch's debug bit to ON state and the configuration bit to OFF state, restart the gateway. HTM-611 is in the debug mode.
2. Use a serial port line to connect the HTM-611's RS-232 port and computer RS-232 serial port, Open the software “HT-123”, Click “Config—Serial Connection”, Select the correct serial port



3. Click “Tool—Show Memory Data” or click on the icon , Interface is as follows:

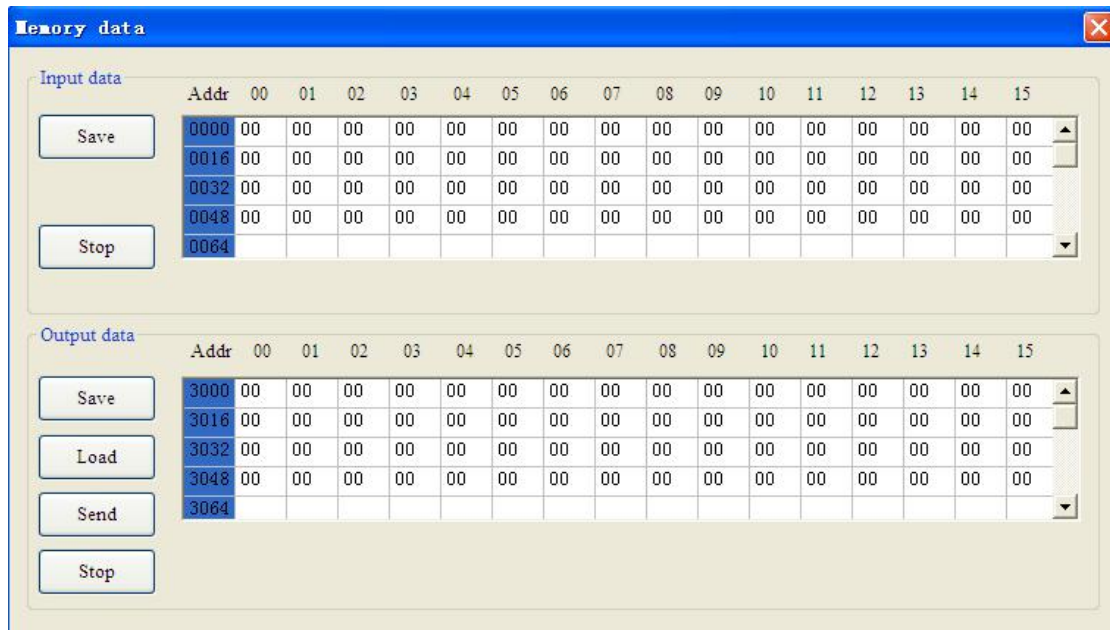

As is shown in the table, upper table shows the memory distribution of HART input data, lower table shows the output data. When you need to change the output data, click the “stop” button firstly, then change the related data or load the already saved data table, at last, click the “sending data”.

4.2.9 Diagnose

Through this function users will know which device is not communicating, execution condition of configured commands, data transmit of gateway and displays of certain command, operating steps are as follows:

1. Set the DIP switch’s debug bit to ON state and the configuration bit to OFF state, back online. HTM-611 is in the debug mode.
2. Use a serial port line to connect the HTM-611’s RS-232 port and computer RS-232 serial port, Open the software “HT-123”, Click “Config—Serial Connection”, Select the correct serial port



3. Click “Tool—Diagnose” or click on the icon , Interface is as follows:

6. Click Node(x), it is shown as below:

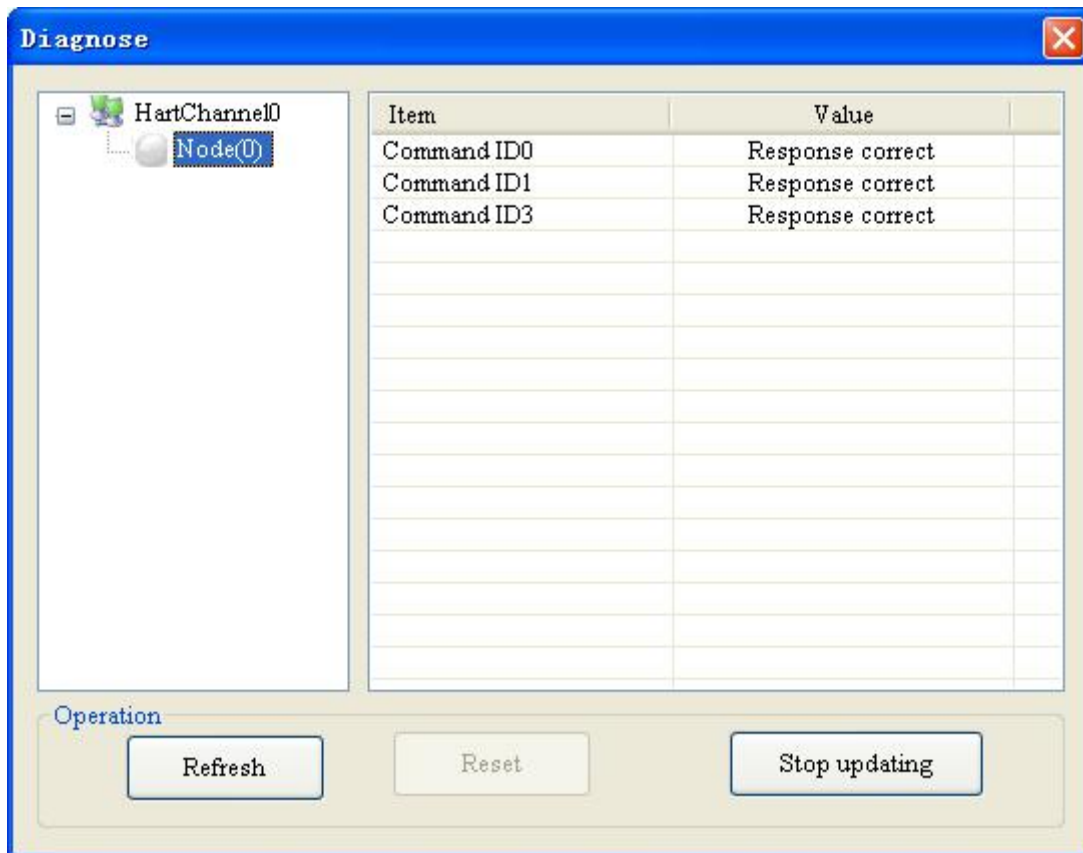

It shows the response status of configured commands.

Click "Refresh" will fresh these command status, "Periodically refresh" will fresh command status once.

7. Double click command 0, 1, 2, 3, 6, 11, 12, 13, 14, 15, 16, 17, 18, 19 will show their command information, command 6, 17, 18 and 19 can start data input.

HTM-611 HART/Modbus Serial Gateway User Manual

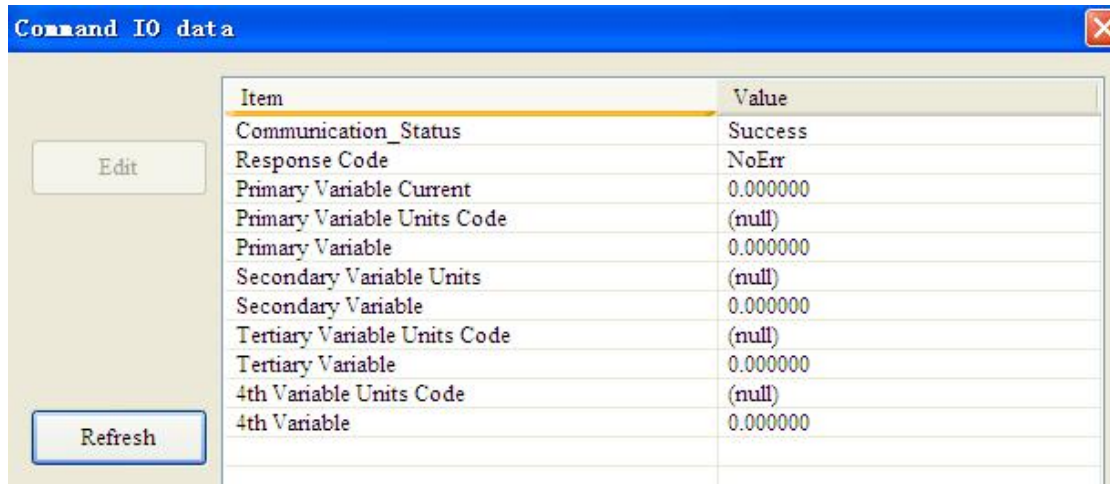

Item	Value
Communication_Status	Success
Response Code	NoErr
Primary Variable Current	0.000000
Primary Variable Units Code	(null)
Primary Variable	0.000000
Secondary Variable Units	(null)
Secondary Variable	0.000000
Tertiary Variable Units Code	(null)
Tertiary Variable	0.000000
4th Variable Units Code	(null)
4th Variable	0.000000

Click the “Refresh” button will update the data, click the “Edit” button doesn’t work in the Read-only command.

Double click “CMD19” will show the window as below:

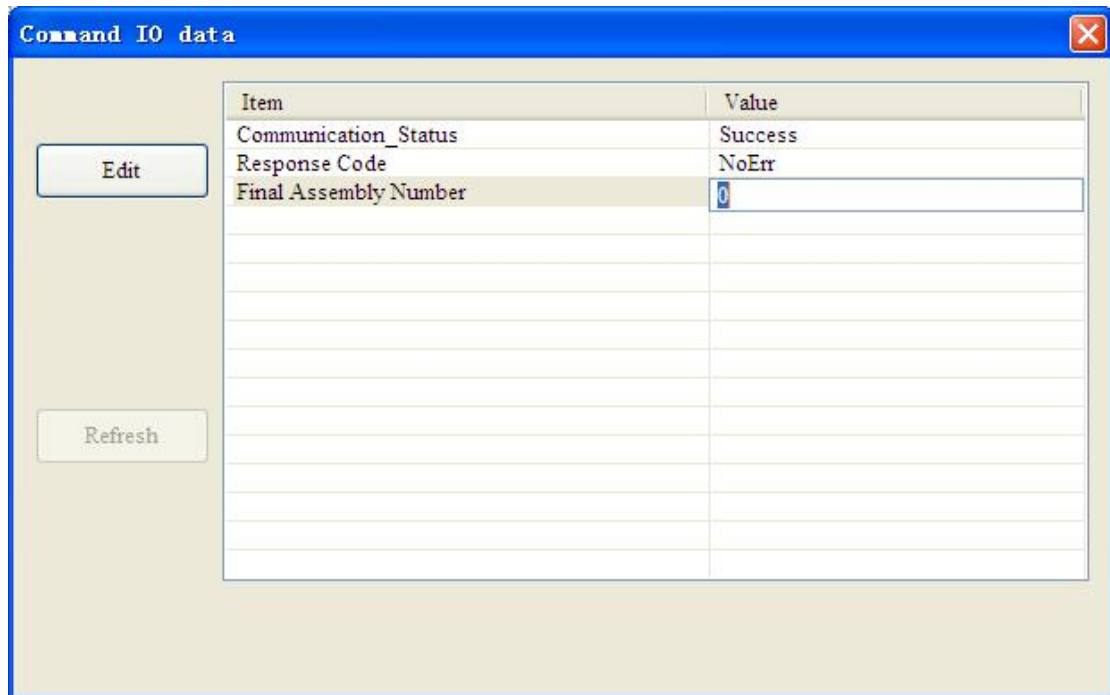

Item	Value
Communication_Status	Success
Response Code	NoErr
Final Assembly Number	0

Click the value or attribute you want to change, like “Final Assembly Number”, change relevant values, and click “Modify” can execute this operation of write command.

4.2.10 Serial Debug

Through this function could send any request message to Hart instruments and record the response information. Steps are as follows:

1. Set the DIP switch's debug bit to ON state and the configuration bit to OFF state, restart the gateway.

Now HTM-611 is in the debug mode.

2. Use a serial port line to connect the HTM-611's RS-232 port and computer RS-232 serial port, Open the software "HT-123", Click "Config—Serial Connection", Select the correct serial port

3. Click "Tool—Serial Debugging Assistant" or click on the icon , Interface is as follows:

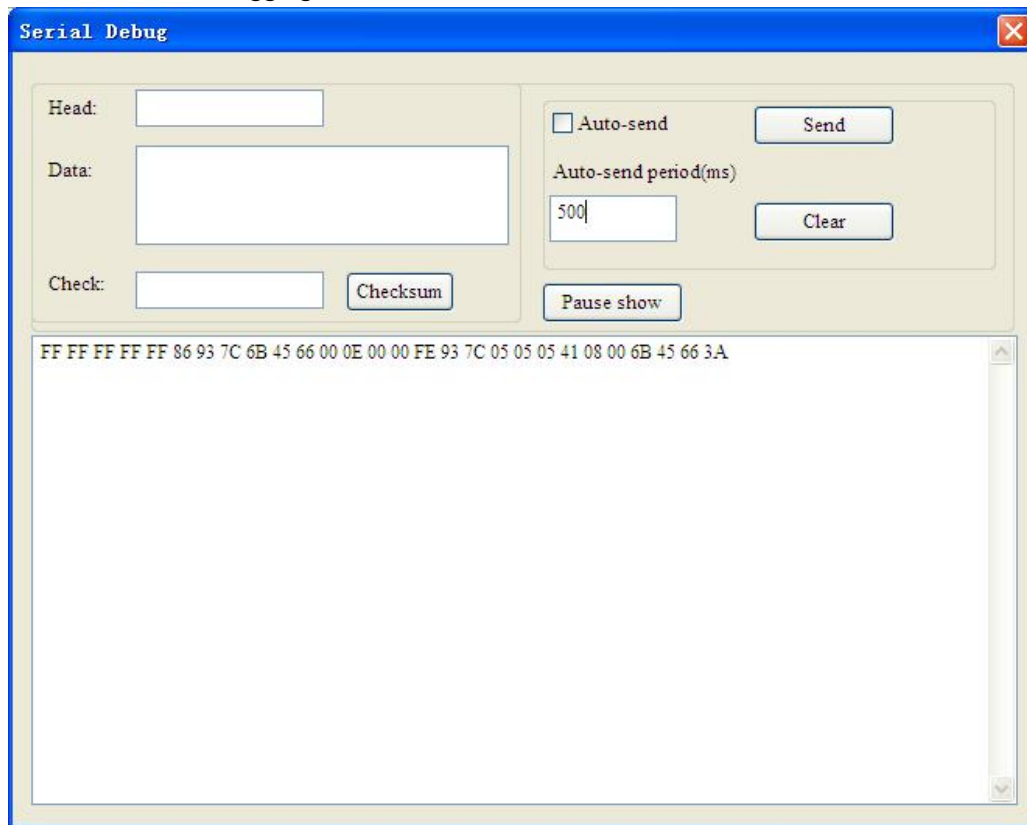

In this interface, click "Auto-send" or "Send" will combine data head, data, and check code into one frame and send out it. The data that the gateway received from HART fieldbus will be shown in the blank place below.

The "Checksum" button only checks part of the data. Here is an example.

HTM-611 HART/Modbus Serial Gateway User Manual

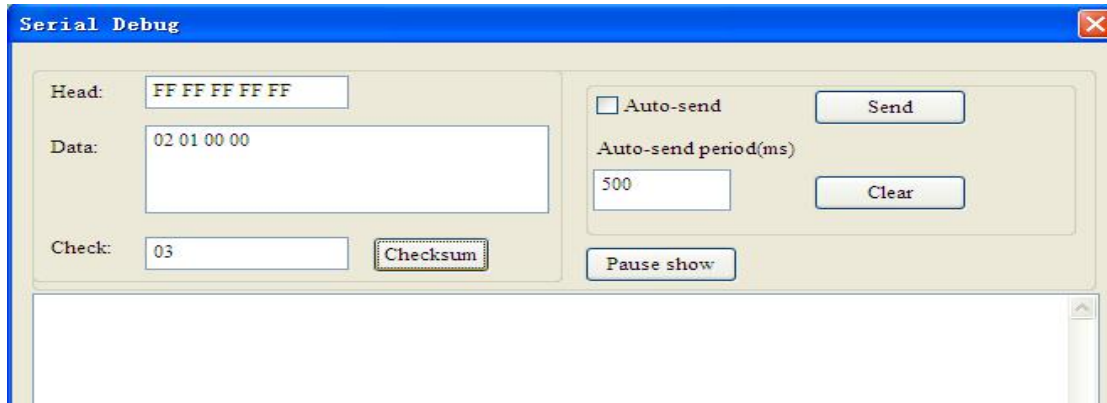

In this example, command ID0 is composed of data head, data and check code. It uses short address; when you click “Send”, you will get the response data.

Note: Under this function, gateway will stop to execute the configured command; Turn off this function, gateway will return to execute the configured command.

4.2.11 Switching Tools

In the “Tools” menu, there are two practical tools: They are used to switch between IEEE754 and PACKED ASCII conveniently.

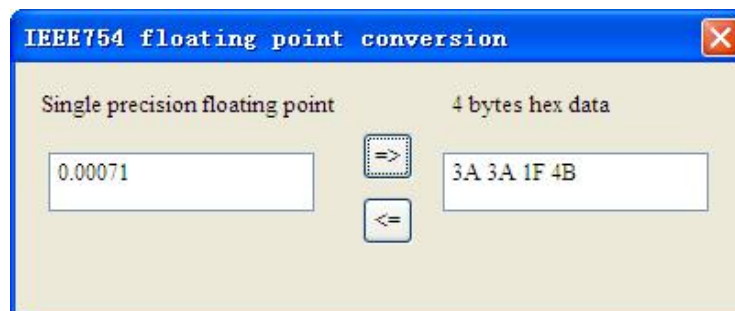
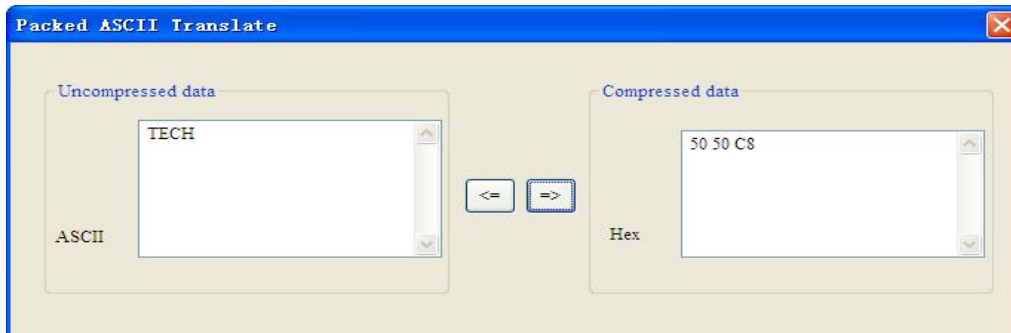

5 Working Principle

Inside the gateway it opens up a length of 5000 bytes of memory as the data exchange of input and output buffers. Memory of 0 to 2999 acts as the storage area of the HART input data and device status. Memory of 3000 to 4999 acts as storage area of the HART output data and control variables. The specific assignment shown in the table below:

	Gateway memory address	Corresponding Modbus register address	Description
Read-only part	0-1599	0-799	The HART data input area
	1600-1619	800-809	Device 0_cmd0 data
	1620-1639	810-819	Device 1_cmd0 data
Device 15_cmd0 data
	1920	960H	Gateway status
	1921	960L	Send times of Gateway's HART port
	1922	961H	Receive times of Gateway's HART port
	1923	961L	HART communication error times
	1924-1943	962-971	Reserved
	1944	972H	Device 0_cmd0's response status
	1945	972L	Device 1_cmd0's response status
Device15_cmd0's response status
	1960-2119	980-1059	The response status of the user command
	2120-2391	1060-1195	Reserved
	2392	1196H	Universal receive label
	2393	1196L	Universal receive Error Counter
	2394-2395	1197	Universal receive data length
	2396-2695	1198-1347	Universal receive data
	2696-2999		Reserved
Readable and writable part	3000-3999	0000-0499	The HART data output area
	4000	0500H	Reset to send, receive, error counter

HTM-611 HART/Modbus Serial Gateway

User Manual

	4001	0500L	Polling enabled
	4002	0501H	Trigger label
	4003	0501L	Trigger command number
	4004-4269	0502-0634	Reserved
	4270	0635H	Universal send label
	4271	0635L	Universal mode enabled
	4272-4273	0636	Universal send data length
	4274-4573	0637-0786	Universal to send data

- The HART data input area: Store the data that HART slave device sends to gateway.
- The HART data output area: Store the data that the gateway sends to the HART slave device.
- Device 0_cmd0~ Device 15_cmd0: When operating a slave command for the first time, the gateway internal will automatically execute the No. 0 command to obtain the device information (to obtain the long address). The response data of this internal command is stored in this area.
- Gateway status: The gateway status indicates what the gateway state is in the HART network, defined as:
 - 0---- No HART communication
 - 1----sending
 - 2---- Waiting for a response
 - 3---- Handling a response
- Send times of HART port on gateway: The HART send counter
- Receive times of HART port on gateway: The HART receive counter
- HART communication error times: The HART Receive error counter
- The response status of Device 0_cmd0~ Device 15_cmd0: Show that the response status of the internal command
- The response status of user command: Show that the response status of the user command
 - Command state is defined:
 - 0---- Not executed
 - 1---- Correct response
 - 2---- Parity error
 - 3---- No answer

4---- Error defined in agreement

5---- Not connected

- Universal Receive label: The receive label under the universal mode, this value which changes one time indicates that HART end receives a HART frame
- Universal receive data length: Indicating the received data length under the universal mode
- Universal Receive Error Counter: Indicate the universal receive error number
- Universal receive data: Store the received data at HART side under the universal mode
- Reset send, receive, error counter: The gateway's control signal, when the value of memory changes, gateway causes all the counter to 0
- Polling is enabled: This bit is readable and writable, writing 1 enables the polling output, writing 0 disables polling output; Reading 1 indicates that the polling state is enabled, 0 indicates that the polling is in the disabled state
- Trigger label: Change the value will result in a trigger operation
- Trigger command number: Command number executed by trigger operation
- Universal mode enabled: The value of 1 indicates a universal transfer function is enabled, otherwise disables universal transport function
- Universal send label: The send label under the universal mode, this value changes in time will lead to send a HART frame
- The universal send data length: The length of send data under the universal mode
- Universal to send data: Data needs to send under the universal mode

5.1 Flowchart of Executing One HART Command

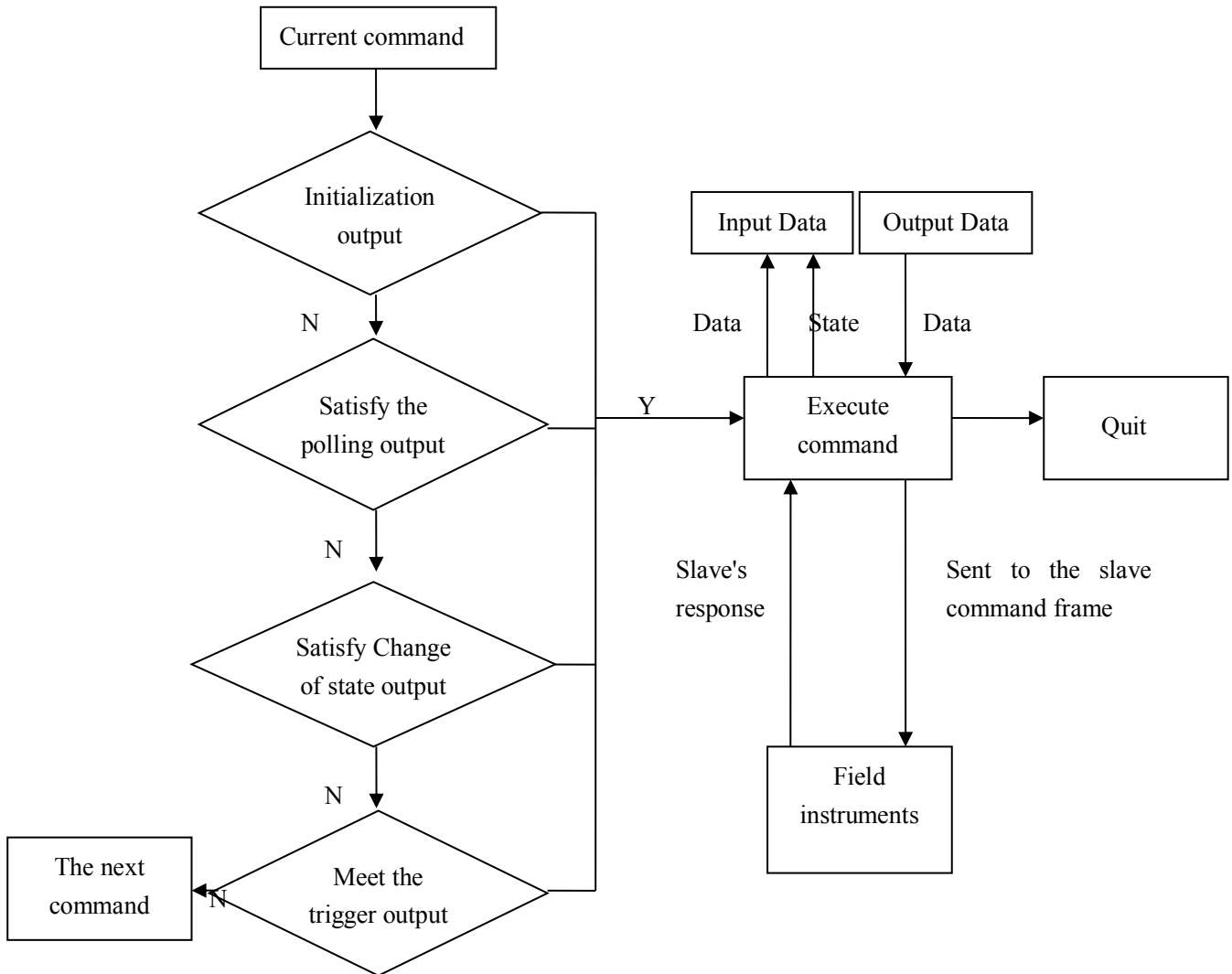

5.2 Universal Send and Receive Data

There are two universal ways for user to select: One is that fieldbus is defined as universal mode. The gateway will receive the serial data in the way of 3.5 character timeout broken frame and send out the data unmodified from the HART interface. Gateway sends data out from serial which is received from HART interface without modification. The character timeout is determined by baud rate, such as 19200, Character timeout is

considered to be $(1/19200) * 10 * 3.5 \approx 2\text{ms}$. The other is to start transmit-receive of HART common frame of HART indirectly through Modbus command, here is an example:

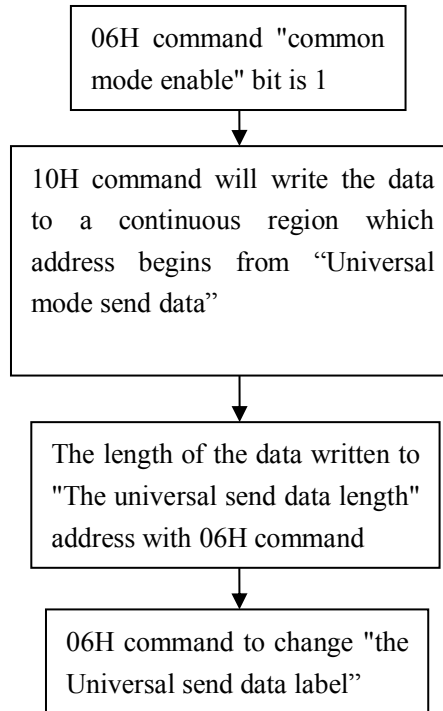

The gateway will store the received HART frame in a continuous region within "the Universal receive data" as a starting address and write the length of the received data in the "Universal received data length". Then change the value of the Universal receive label". If no data is received within the response waiting time, the gateway will order "universal receive error counter" to plus 1. Before sending the general frame, user should read the universal receive label and the error counter. After transmitting the general frame, it needs to read these two values continuously until one of them changes.

5.3 Trigger Command

Users can use Modbus command to trigger any HART command which is configured by gateway. The specific approach is: using command ID6 of Modbus to write the user command number which needs to be triggered (when HT-123 configures commands, the software will automatically calculate and display) to the "trigger command number". Then rewriting "the trigger label" can trigger the value to change and trigger the

gateway to finish a trigger operation. Parts of response data in the device will be stored to "the receive data memory" which specified by this command number.

5.4 Data Exchange with Modbus

When fieldbus is configured as "Modbus slave", user can exchange data, inquire about the status of gateway and manage according to the corresponding address of gateway in the internal input and output buffer; Also you can do some trigger operation and transmission of common frame.

6 Installation

6.1 Machine Dimension

Size: 0.98 in (width)*3.94 in (height)*3.54 in (depth)

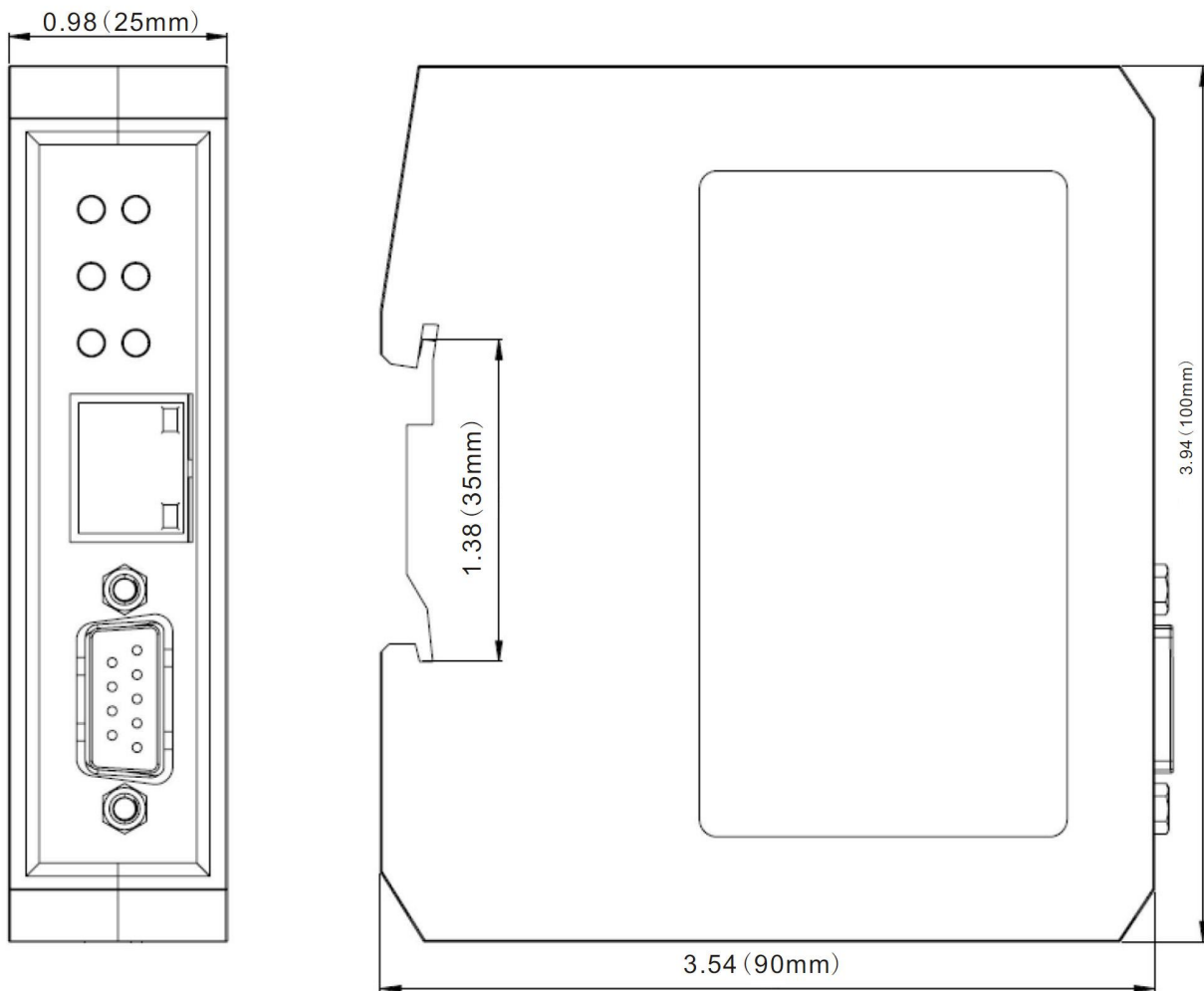

6.2 Installation Method

Using 1.38 in (35mm) DIN RAIL

Installing the gateway

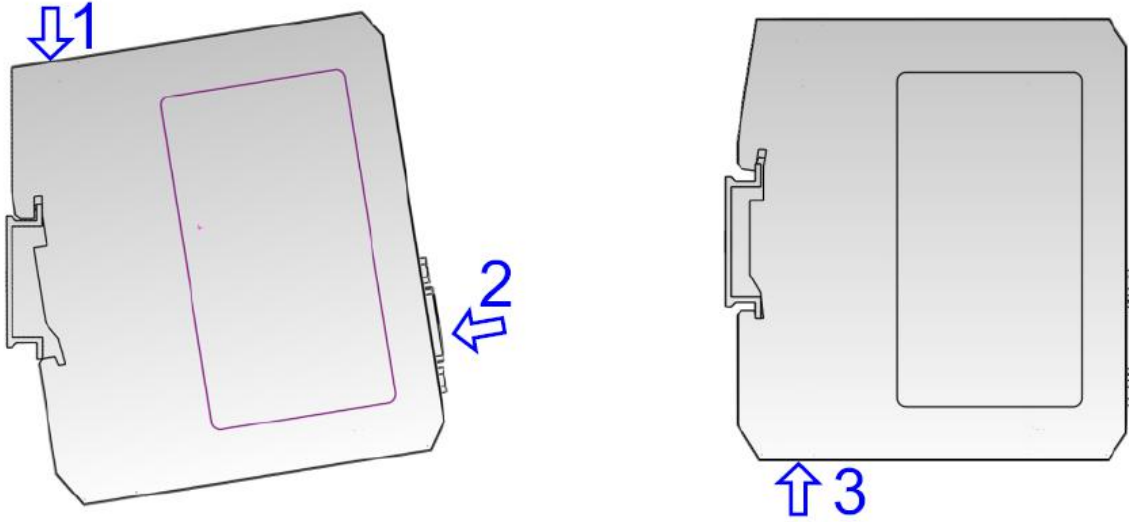

Uninstalling the gateway

